

**QN ATTENUATOR**

**6 DB 3 GHZ 1W**

**R412.306.124**

Series : ATTENUATOR

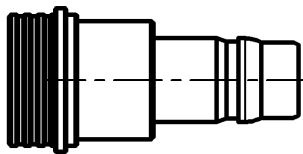
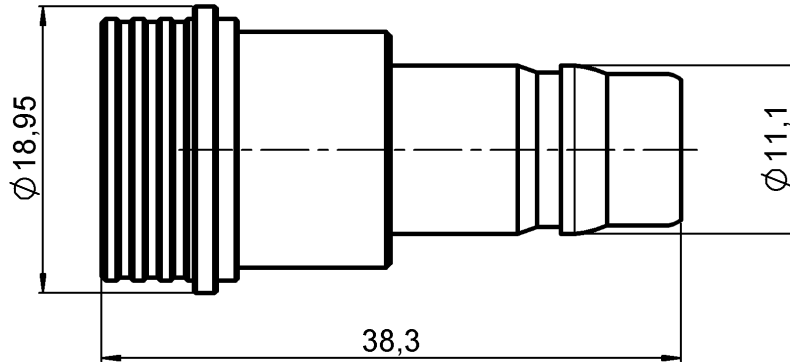

Ech : 1

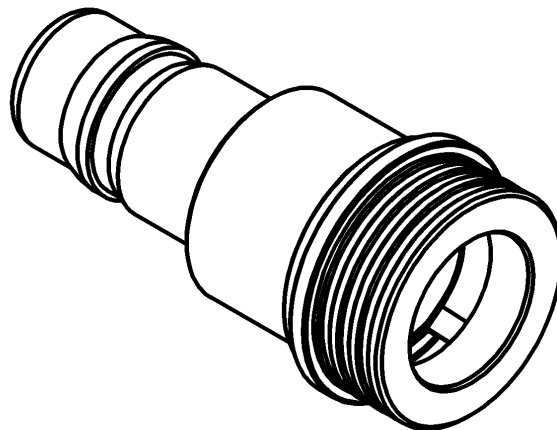

All dimensions are in mm.

COMPONENTS	MATERIALS	PLATING( $\mu\text{m}$ )
BODY	BRASS	BBR 0.5 OVER SILVER 3
MALE CENTER CONTACT	BRASS	GOLD 1.3 OVER COPPER 2.5
FEMALE CENTER CONTACT	BERYLLIUM COPPER	GOLD 1.3 OVER COPPER 2.5
OUTER CONTACT	BERYLLIUM COPPER	Teccoat 602-03
INSULATOR	PTFE	
GASKET	EPDM	
SUBSTRATE	ALUMINA	
RESISTOR	THICK FILM	
OTHERS PARTS		

Issue : 0404 A

In the effort to improve our products, we reserve the right to make changes judged to be necessary.

**QN ATTENUATOR**

**6 DB 3 GHZ 1W**

**R412.306.124**

Series : ATTENUATOR

**ELECTRICAL CHARACTERISTICS**

Frequency (GHz)	2	2 - 3
V.S.W.R (≤)	1.20	1.30
Deviation(±dB)	0.30	0.50

Operating Frequency Range	DC - 3	GHz
Impedance	50	Ω
Nominal Attenuation	6	dB
Peak power at 25°C (1μs, 1%)	100	W
Average power at 25°C	1	W (Free Air Cooled)

**MECHANICAL CHARACTERISTICS**

Connectors	QN	Male Female
Weight	28.378	g

**ENVIRONMENTAL CHARACTERISTICS**

Operating temperature range	-40 / +85 °C
Storage temperature range	-40 / +85 °C

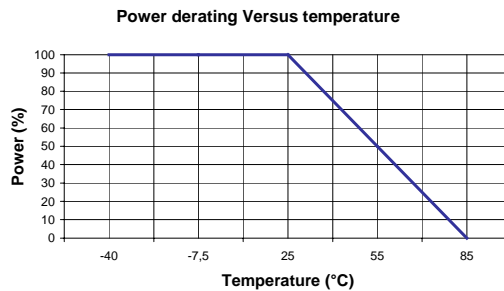

**SPECIFICATION**

**OTHER CHARACTERISTICS**

Mating Life : 100 Cycles

**Issue : 0404 A**

In the effort to improve our products, we reserve the right to make changes judged to be necessary.